

DIVANO COLLEZIONE SINGAPORE/ SINGAPORE SPECIAL

SCHEMA TECNICA

SINGAPORE

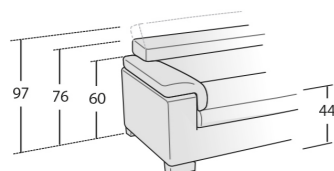

Possibilità • Possibility

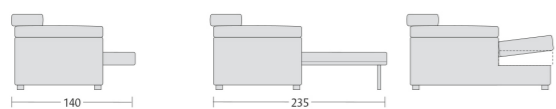

Divano con seduta estraibile aperta Divano letto aperto Elementi contenitore

Finitura a bottoni su cuscino seduta e poggiatesta

SINGAPORE SPECIAL

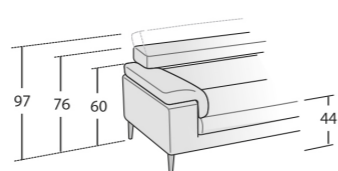

Possibilità • Possibility



Divano con seduta estraibile aperta Versione letto e contenitore non disponibile

Finitura a bottoni su cuscino seduta e poggiatesta



Penisola angolare dx/sx
BR23 L 102 P 205 H 76/97
BR15 L 94 P 205 H 76/97
• Contenitore



Penisola angolare relax motorizzata dx/sx
BR23 L 102 P 238 H 76/97
BR15 L 94 P 238 H 76/97



Penisola angolare c/pouff dx/sx
BR23 L 102 P 218 H 76/97
BR15 L 94 P 218 H 76/97



Penisola angolare c/pouff dx/sx
BR23 L 102 P 238 H 76/97
BR15 L 94 P 238 H 76/97



Angolo penisola dynamic c/pouff dx/sx
L 105 P 220 H 76/97
• 3 poggiatesta reclinabili



Angolo retto dynamic L 105 P 105 H 76/97
• 2 poggiatesta reclinabili



Angolo retto dynamic dx/sx
L 105 P 140 H 76/97
• 2 poggiatesta reclinabili

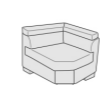

Angolo aperto L 130 P 130 H 76



Pouff
L 80 P 60 H 44
L 60/70/80 P 105 H 44
L 90/140 P 105 H 44
• Contenitore

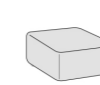

Pouff mono
L 75 P 75 H 42
L 95 P 95 H 42
L 115 P 115 H 42

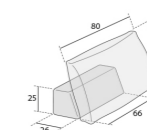

Pacchetto schiena Witty



Cuscino decoro L 40x40



Cuscino decoro L 55x45



Cuscino poggiatesta L 75x27
(divano cm 215, divano lat. cm 196, panchetta maxi)



Cuscino poggiatesta L 65x27
(divano cm 195, divano lat. cm 176, poltrona maxi lat., panchetta, penisola ang. c/pouff)



Cuscino poggiatesta L 55x27
(divano cm 175, divano cm 245, divano lat. cm 156, divano lat. cm 226, poltrona, poltrona lat. componibile panchetta reversibile cm 245, angolo penisola c/pouff)



Cuscino poggiatesta L 45x27
(divano cm 155, divano lat. cm 136, componibile panchetta reversibile cm 226)

COMPLEMENTI: LAMPADA A LED, CARICABATTERIA WIRELESS, ACCESSORIO POP

Lampada a Led touch, pieghevole e facilmente rimovibile
Touch led lamp, foldable and easily pull-out



Posizione lampada a led e caricabatteria wireless su:

- bracciolo penisola angolare, penisola angolare con pouff

- bracciolo penisola angolare relax

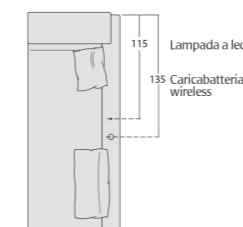
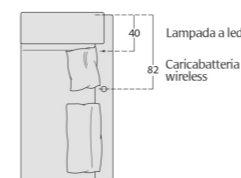

Caricabatteria Wireless posizionato sotto il rivestimento, per dispositivi idonei
Wireless charger under the cover, for suitable devices







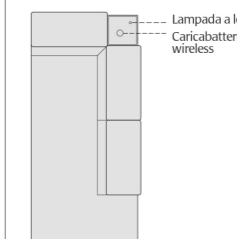

Accessorio Pop antracite opaco disponibile nelle versioni:
Pop piano, Pop caricabatteria, Pop lampada, Pop multifunzione
Pop matt anthracite accessory available in the versions:
Pop top, Pop battery charger, Pop lamp, Pop multifunction

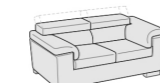
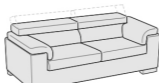
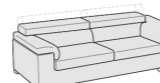
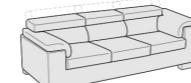

Posizione accessorio Pop su:

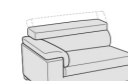
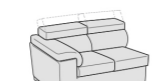
- angolo penisola dynamic dx/sx, angolo retto dynamic, angolo retto dynamic dx/sx

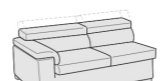
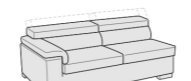
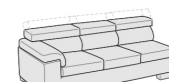
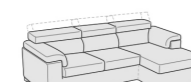
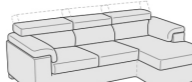
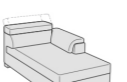

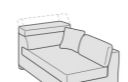
 Poltrona L 108 P 105 H 76/97 • Seduta estraibile	 Divano con seduta unica L 155 P 105 H 76/97 • Seduta estraibile • Letto	 Divano L 155 P 105 H 76/97 • Sedute estraibili • Letto	 Divano L 175 P 105 H 76/97 • Sedute estraibili • Letto	 Divano L 195 P 105 H 76/97 • Sedute estraibili • Letto	 Divano L 215 P 105 H 76/97 • Sedute estraibili • Letto	 Divano L 245 P 105 H 76/97 • Sedute estraibili • Letto
 Poltrona laterale dx/sx L 89 P 105 H 76/97 • Seduta estraibile	 Poltrona maxi laterale dx/sx L 99 P 105 H 76/97 • Seduta estraibile	 Divano laterale seduta unica dx/sx L 136 P 105 H 76/97 • Seduta estraibile • Letto	 Divano laterale dx/sx L 136 P 105 H 76/97 • Sedute estraibili • Letto	 Divano laterale dx/sx L 156 P 105 H 76/97 • Sedute estraibili • Letto	 Divano laterale dx/sx L 176 P 105 H 76/97 • Sedute estraibili • Letto	 Divano laterale dx/sx L 196 P 105 H 76/97 • Sedute estraibili • Letto
 Divano laterale dx/sx L 226 P 105 H 76/97 • Sedute estraibili • Letto	 Componibile panchetta reversibile L 230 P 160 H 76/97 • Letto	 Componibile panchetta reversibile L 245 P 160 H 76/97 • Letto	 Panchetta dx/sx L 98 P 160 H 76/97 • Contenitore	 Panchetta maxi dx/sx L 108 P 160 H 76/97 • Contenitore	 Penisola angolare dx/sx BR23 L 102 P 185 H 76/97 BR15 L 94 P 185 H 76/97 • Contenitore	

DIVANO COLLEZIONE SINGAPORE/ SINGAPORE SPECIAL

SCHEMA TECNICA

SINGAPORE



Piede in legno Brick colore nero di serie, colore beige optional.
Standard black finish wooden Brick foot, beige finish optional.



Piede in metallo Base finitura cromo o manganese optional.
Chrome or manganese finish metal Base foot optional.

Piede in metallo Line finitura cromo o manganese optional.
Chrome or manganese finish metal Line foot optional.

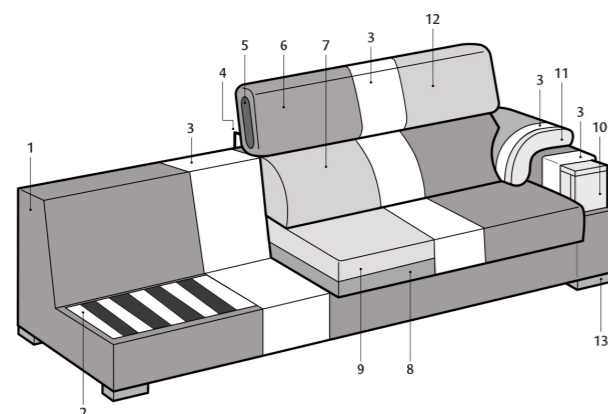

- Struttura in legno stagionato e agglomerato • Frame in seasoned wood and agglomerated wood.
- Molleggio seduta nastri elastici in fibra propilenica e lattice da 80 mm tesi meccanicamente • Seat sprung in mechanically-tensioned 80-mm propylene fibre and latex webbing.
- Rivestimento in ovatta di poliestere gr 300 • Covered in 300 gr polyester wadding.
- Meccanismo cromato per movimento poggiatesta • Chromed back/headrest mechanism.
- Insero in legno stagionato • Seasoned wood insert.
- Cuscino poggiatesta in poliuretano espanso indeformabile D 18 • Headrest cushion in non-deforming D 18 polyurethane foam.
- Cuscino lombare in poliuretano espanso indeformabile D 21 • Lumbar cushion in non-deforming D 21 polyurethane foam.
- Cuscino seduta in poliuretano espanso indeformabile D 32 • Seat cushion in non-deforming D 32 polyurethane foam.
- Bombatura seduta in poliuretano espanso indeformabile D 28 • Seat upholstery in non-deforming D 28 polyurethane foam.
- Imbottitura bracciolo in poliuretano espanso indeformabile D 40 • Armrest padding in non-deformable D40 polyurethane foam.
- Cuscino bracciolo in poliuretano espanso indeformabile D 21/30 • Armrest cushion in non-deformable D 21/30 polyurethane foam.
- Rivestimento in tessuto, pelle o ecopelle • Covered in fabric, leather or eco leather.
- PIEDE DI SERIE • STANDARD FOOT
 - Piede in legno Brick colore nero • Black wooden Brick foot.
- PIEDI OPTIONAL • OPTIONAL FOOT
 - Piede in legno Brick colore beige • Beige wooden Brick foot.
 - Piede in metallo Base e Line finitura cromo o manganese • Chrome or manganese finish metal Base and Line foot.

SINGAPORE SPECIAL



Piede in metallo Link finitura nichel nero di serie, finitura cromo optional.
Standard black nickel finish metal Link foot, chrome finish optional.



Piede in metallo Model finitura cromo o manganese optional.
Optional chrome or manganese finish metal Model foot.

Piede in metallo Zed finitura cromo o manganese optional.
Optional chrome or manganese finish metal Zed foot.

Piede in metallo Abby finitura cromo o manganese optional.
Optional chrome or manganese finish metal Abby foot.

Piede in metallo Split finitura cromo o manganese optional.
Optional chrome or manganese finish metal Split foot.

Piede in metallo Sky finitura cromo o manganese optional.
Optional chrome or manganese finish metal Sky foot.

Piede in metallo Cross finitura cromo o manganese optional.
Optional chrome or manganese finish metal Cross foot.

Piede in metallo Frame finitura grigio o manganese optional.
Optional grey or manganese finish metal Frame foot.

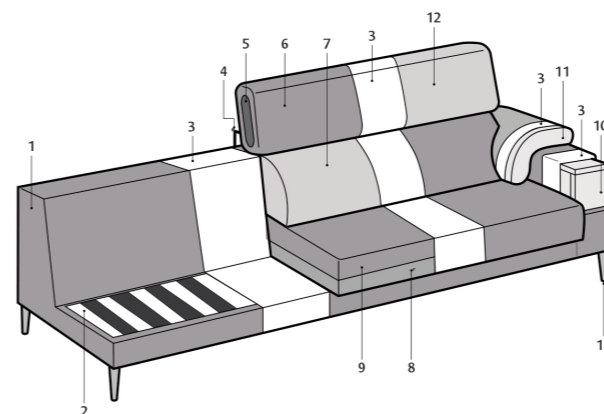

- Struttura in legno stagionato e agglomerato • Frame in seasoned wood and agglomerated wood.
- Molleggio seduta nastri elastici in fibra propilenica e lattice da 80 mm tesi meccanicamente • Seat sprung in mechanically-tensioned 80-mm propylene fibre and latex webbing.
- Rivestimento in ovatta di poliestere gr 300 • Covered in 300 gr polyester wadding.
- Meccanismo cromato per movimento poggiatesta • Chromed back/headrest mechanism.
- Insero in legno stagionato • Seasoned wood insert.
- Cuscino poggiatesta in poliuretano espanso indeformabile D 18 • Headrest cushion in non-deforming D 18 polyurethane foam.
- Cuscino lombare in poliuretano espanso indeformabile D 21 • Lumbar cushion in non-deforming D 21 polyurethane foam.
- Cuscino seduta in poliuretano espanso indeformabile D 32 • Seat cushion in non-deforming D 32 polyurethane foam.
- Bombatura seduta in poliuretano espanso indeformabile D 28 • Seat upholstery in non-deforming D 28 polyurethane foam.
- Imbottitura bracciolo in poliuretano espanso indeformabile D 40 • Armrest padding in non-deformable D40 polyurethane foam.
- Cuscino bracciolo in poliuretano espanso indeformabile D 21/30 • Armrest cushion in non-deformable D 21/30 polyurethane foam.
- Rivestimento in tessuto, pelle o ecopelle • Covered in fabric, leather or eco leather.
- PIEDE DI SERIE • STANDARD FOOT
 - Piede in metallo Link finitura nichel nero • Black nickel finish metal Link foot.
- PIEDI OPTIONAL / OPTIONAL FOOT
 - Piede in metallo Link finitura cromo • Chrome finish metal Link foot.
 - Piede in metallo Model, Zed, Abby, Split, Sky e Cross finitura cromo o manganese • Chrome or manganese finish metal Model, Zed, Abby, Split, Sky, Cross foot.
 - Piede in metallo Frame finitura grigio o manganese • Grey or manganese finish metal Frame foot.